

LOUISE GASKILL

C O M P A N Y

— original art lighting & drapery hardware —





Louise Gaskill Company

Exquisite detailing defines Louise Gaskill Company. Known in the lighting industry for vintage glass designs and gilt finishes, Louise extends this same vision to her boutique line of drapery hardware. The use of acrylics and hand gilded shapes is distinctly vintage in feel yet modern in design.

- 12 Art Finial styles
- French Return Collection
- Acrylic and wood rods - available in 1.5", 1.75", and 2" diameters
- Coordinating rings and brackets

FINISHES

Gilded finishes are available in gold or silver leaf. Due to the nature of gilding techniques, metal finishes can vary slightly from piece to piece.

INSTALLATION RECOMMENDATIONS

A professional installer is recommended for your hardware installation.

Three support brackets are suggested for every 8 feet of rod. Consult your installer or fabricator for guidance on bracket requirements as drapery weight and rod diameter may impact bracket count.

Acrylic, wood, and French Return rods may be joined to extend overall length. The connector options will be included as required. A center bracket must be used when joining two rods together for support and to hide seaming.

Art Finials

Finials are sold individually.
Please specify finish when placing order.
Our finials coordinate with our rods. Industry standards vary and other rods may not fit our finials.
Finials are available in gold or silver leaf.
All finials have a rod insert length of 1 1/8" which is included in the overall length.

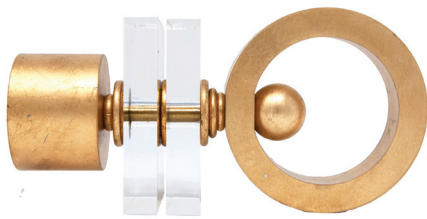

Anna
3"H x 6"L



Bella
3 1/2"H x 3"L



Charlotte
5"H x 6 1/2"L

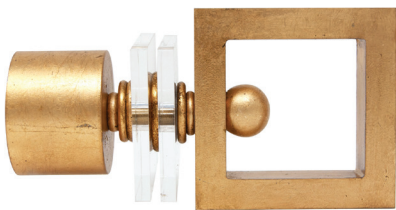

Daisy
3"H x 5"L



Gracie
2 1/2"H x 5"L



Kat
2 1/2"H x 5"L

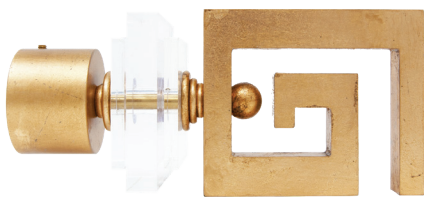

Ki
3"H x 6 1/2"L

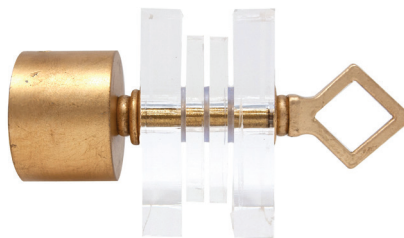

Lisa
2 1/2"H x 5"L



Lu
10 3/4"H x 4"L



Pia
3"H x 5 1/2"L



Rose
3"H x 6"L



Uma
4"H x 7 1/2"L

Acrylic and Wood Rods

Acrylic rods are available in 1.5", 1.75", and 2" diameters - 8' lengths
 Wood rods are available in 1.5", 1.75", and 2" diameters - 6' lengths
 Rods can be custom cut upon request.

Wood rods are available in gold or silver leaf.
 Please specify finish when ordering.

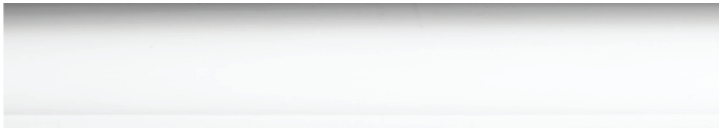

Acrylic Rod	Part No.
1.5" diameter rod	ROD-A1.5
1.75" diameter rod	ROD-A1.75
2" diameter rod	ROD-A2



Gold Gilt Wood Rod	
1.5" diameter rod	ROD-W1.5
1.75" diameter rod	ROD-W1.75
2" diameter rod	ROD-W2



Silver Gilt Wood Rod	
1.5" diameter rod	ROD-W1.5
1.75" diameter rod	ROD-W1.75
2" diameter rod	ROD-W2

End Bracket

- 3 bracket sizes for 1 1/2", 1 3/4", and 2" rods.
- Brackets are available in gold or silver leaf.
- Backplate dimensions: 4" H x 1.25" W
- Set screw on top of bracket to keep rod in place.



Bracket sizes:	Part No.
1 1/2" rod Projection: 4.88"	BR-E1.5
1 3/4" rod Projection: 5.75"	BR-E1.75
2" rod Projection: 5.75"	BR-E2

Center Bracket

- Center bracket is used when joining two rods together.
- All measurements are the same as the coordinating end bracket.
- Rod holder is slightly wider to hide seaming of rods.



Bracket sizes:	Part No.
1 1/2" rod Projection: 4.88"	BR-C1.5
1 3/4" rod Projection: 5.75"	BR-C1.75
2" rod Projection: 5.75"	BR-C2



Photography
Dustin Peck
Photography
Interior Design
Brooke Cole
Interiors

French Return Collection

End Bracket

Elegant 5" projection.
Hand forged design to support a variety of drapery fabrics.
Brackets are available in gold or silver leaf.
Two backplate options: rectangular or oval.
Backplate: 4" H x 1.25" W
Sold individually.

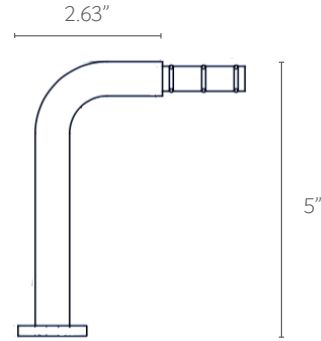

Rectangular backplate end bracket

Part No. FREB-R



Oval backplate end bracket

Part No. FREB-O



Center Bracket

Projection: 5.38"
Backplate dimensions: 3" H x 1.25" W
Sold individually.

Rectangular backplate center bracket

Part No. FRCB-R

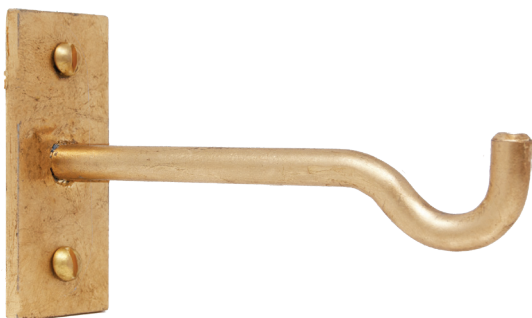

Oval backplate center bracket

Part No. FRCB-O



5/8" French Return Rod

Rods are available in gold or silver leaf.
Available in 4 ft, 6 ft, and 8 ft lengths. Custom cut upon request.
Please specify finish when ordering.

Gold Gilt Metal Rod



	Part No.
4 ft	FRMR4
6 ft	FRMR6
8 ft	FRMR8

Silver Gilt Metal Rod



	Part No.
4 ft	FRMR4
6 ft	FRMR6
8 ft	FRMR8

Rings

Sold individually.
Rings are available in gold or silver leaf.



Wood Ring

Part No.

WR1 Suitable for 5/8" and 1 1/2" rods.
ID: 1 3/4"
OD: 2 3/4"

WR2 Suitable for 1 1/2", 1 3/4", and 2" rods.
ID: 2 5/8"
OD: 3 3/4"



Metal Ring

Part No.

MR1 Suitable for 5/8" French Return rod.
ID: 1 1/2"
OD: 1 7/8"

MR2 Suitable for 1 1/2", 1 3/4", and 2" rods.
ID: 2 1/8"
OD: 2 1/2"



*Photography Alden
Parkes
Interior Design
Shannon Ggem*

louisegaskill.com

919.601.3525

All Louise Gaskill products are proudly designed
and produced in our Raleigh, NC studio.

LOUISE GASKILL
C O M P A N Y